

**ELKO EP, s.r.o.**  
 Palackého 493  
 769 01 Holešov, Vsetuly  
 Czech Republic  
 Tel.: +420 573 514 211  
 e-mail: elko@elkoep.com  
 www.elkoep.com

Made in Czech Republic

02-21/2017 Rev.: 2



## TER-9

### Multifunction digital thermostat



#### Characteristics

- Digital thermostat with 6 functions and built-in time switch clock with day, week and year program. You can also limit temperature functions and courses this way in real time.
- The temperature profile can be changed using the time program.
- Complex home and water heating, solar heating, etc.
- Two thermostats in one, two temperature inputs, two outputs with dry contact.
- Maximum universal and variable thermostat including all ordinary thermostat functions.
- Functions: two independent thermostats, dependent thermostat, differential thermostat, two level thermostat, zone-based thermostat, dead zone thermostat.
- Monitoring function for short circuit or sensor disconnection.
- Program setting of output functions, calibration of sensors according to reference temperature (offset).
- The thermostat is subject to the digital clock programs.
- Wide range for setting control temperature - 40 to 110°C.
- Clear display of set and measured data on a backlit LCD.
- Switching modes:
  - *AUTO* – automatic switching mode:
    - *PROGRAMME* ☉ – switching based on a programme (astro or time).
    - *RANDOM* 🎲 – switches randomly in a 10–120 minute interval.
    - *HOLIDAYS* 🗓 – holiday mode – option of setting up a period for which the timer will be blocked, i.e. will not switch based on the set programmes.
    - *MANUAL* 🗑 – manual mode – option of controlling the individual output relays manually.
- Options of the automatic switching programme:
  - *TER* - switches according to set thermostat function (switches based on temperature sensors and associated function).
  - *TIME PROGRAM* - switches or sets required temperature according to set time program.
- 100 memory locations for time programs (common for both channels).
- Programming can be performed under voltage and in backup mode.
- The relay outputs do not work in backup mode (battery-powered).
- Choice of menu display - EN / CZ / RU / HU / ES / PL / SK (factory setting EN).
- Choice of automatic daylight savings time transition according to time zone.
- Backlit LCD display.
- Easy and quick setting with the help of 4 control buttons.
- Pluggable transparent cover on front panel.
- The time switch clock has a battery backup, which retains data in case of a power outage (reserve backup time - up to 3 years).
- Power supply: AC 230V or 24V AC/DC (based on type of device).
- 2-module, DIN rail mounted.

#### Symbol

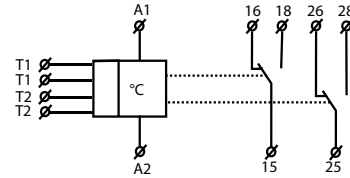

#### Connection

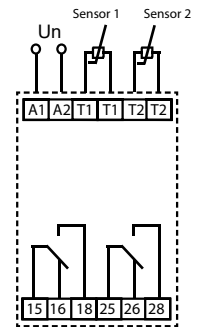

#### Description

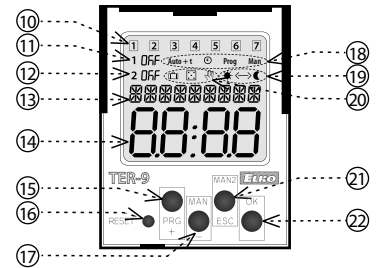
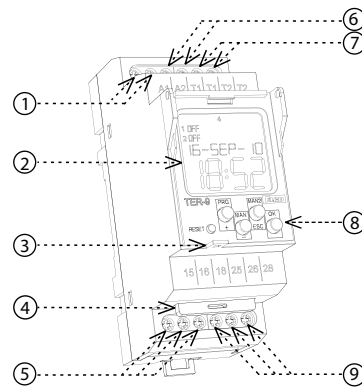

1. Supply voltage terminals
2. Display with back-light
3. Place for seal
4. Plug-in module for replacing backup battery
5. Output - channel 1 (15-16-18)
6. Terminals - sensor 1
7. Terminals - sensor 2
8. Control buttons
9. Output - channel 2 (25-26-28)
10. Indicates the day in the week
11. Indication (1st channel)
12. Indication (2nd channel)
13. Display of data / settings menu / or display of current measured temperature
14. Time display
15. Control button PRG / +
16. Reset
17. Control button MAN1 / -
18. Operating modes indication

19. 12/24 hours format / AM 🌞 ← - 🌙; PM 🌙 → - 🌞
20. Indication of the switch program
21. Control button MAN2 / ESC
22. Control button OK. Switches display date / measured temperature of channel 1, 2

**CONTROL OF A DISPLAY WITH BACKLIGHT**  
 Power on: Display is illuminated with a backlight for 10 seconds from the last button press. The display continuously shows the settings – date, time, day of the week, contact state and programme. Permanent on / off is activated by simultaneous presses of the MAN, ESC, OK buttons. After activating the permanent on/off, the display will flash briefly.  
 Backup mode: After 2 minutes, the display switches to the sleep mode, i.e. shows no information. The display can be activated by pressing any button.

Type of load	 cos φ ≥ 0.95	M	M						
Mat. contacts AgNi, contact 8A	250V / 8A	250V / 3A	250V / 2A	230V / 1.5A (345VA)	x	300W	x	250V / 1A	250V / 1A
Type of load									
Mat. contacts AgNi, contact 8A	x	250V / 3A	250V / 3A	24V / 8A	24V / 3A	24V / 2A	24V / 8A	24V / 2A	x

TER-9

Supply	
Supply terminals:	A1 - A2
Supply voltage:	AC 230 V (AC 50-60 Hz), galvanically isolated or AC/DC 24 V, not galvanically isolated
Consumption:	max. 4 VA / 0.5 W
Max. dissipated power (Un + terminals):	3 W
Supply voltage tolerance:	-15 %; +10 %
Backup battery type:	CR 2032 (3V)

Measuring circuit	
Measuring terminals:	T1-T1 and T2-T2
Temperature range:	-40.. +110 °C
Hysteresis (sensitivity):	adjustable within range 0.5...5 °C
Diference:	adjustable 1 .. 50 °C
Sensor:	thermistor NTC 12 kΩ at 25 °C
Sensor failure indication (overrun):	displayed on LCD *

Accuracy	
Measuring accuracy:	5 %
Repeat accuracy:	< 0.5 °C
Temperature dependance:	< 0.1 % / °C
Number of function:	6

Output	
Number of contacts:	1x switching for each output (AgNi)
Rated current:	8 A / AC1
Switching capacity:	2000 VA / AC1, 240 W / DC
Switching voltage:	250 V AC / 30 V DC
Output indication:	symbol ON/OFF
Mechanical life:	1x10 <sup>7</sup>
Electrical life (AC1):	1x10 <sup>5</sup>

Time circuit	
Real time back-up:	up to 3 years
Accuracy:	max. ±1s/ day at 23°C
Minimum interval:	1 min.
Data stored for:	min. 10 years

Program circuit	
Number of memory places:	100
Program:	daily , weakly, yearly
Data readout:	LCD display, with back light

Other information	
Operating temperature:	-10.. +55 °C
Storage temperature:	-30.. +70 °C
Electrical strength:	4 kV (supply - output)
Operating position:	any
Mounting:	DIN rail EN 60715
Protection degree:	IP40 from front panel / IP20 clips
Overvoltage cathegory:	III.
Pollution degree:	2
Max. cable size (mm <sup>2</sup> ):	max. 1x 2.5, max. 2x 1.5 / with sleeve max. 1x 2.5
Dimensions:	90 x 35 x 64 mm
Weight:	(230V) 150 g, (24V) 113 g
Standards:	EN 61812-1; EN 61010-1; EN 60730-2-9; EN 60730-1; EN 60730-2-7

\* **ERROR** - sensor short circuit - the relay is disconnected  
**NO SENSOR** - interruption sensor - the relay is disconnected

mode precedence	display	output mode
mode with the highest priority >>>	ON / OFF	manual control
>>	ON / OFF	holiday mode
>	ON / OFF	time program <b>Prog</b>
	TER	thermostat

TER and TIME PROGRAM can work at the same time on a single channel.

Control description

	Prog	entrance into programming menu
	←	browsing in menu setting of values
	→	quick shifting during setting of values
	⏏	entrance into required menu confirmation switch. between display
	↑	one level up
	↓	a step back
	⏪	back to the starting menu

Device differs short and long button press. In the manual marked as:  
○ - short button press (<1s)  
● - long button press (>1s)

After 30s of inactivity (from the last press of any button) will device automatically returns into starting menu.

In the start screen, press ⏏ to toggle between displaying the date or measured temperature.

Language settings

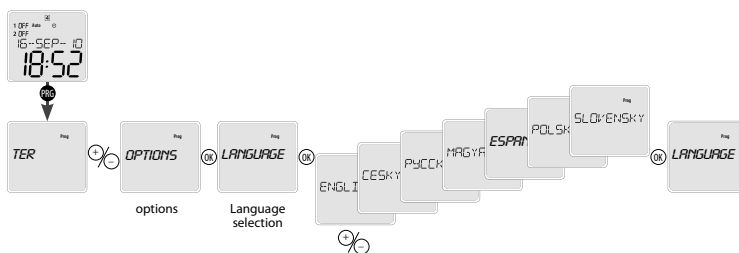

Temperature sensor TC, TZ



Resistance value of sensors based on temperature

Temperature (°C)	NTC sensor (kΩ)
20	14.7
30	9.8
40	6.6
50	4.6
60	3.2
70	2.3

Tolerance of sensor NTC 12 kΩ is ± 5% at 25 °C.

## Menu overview

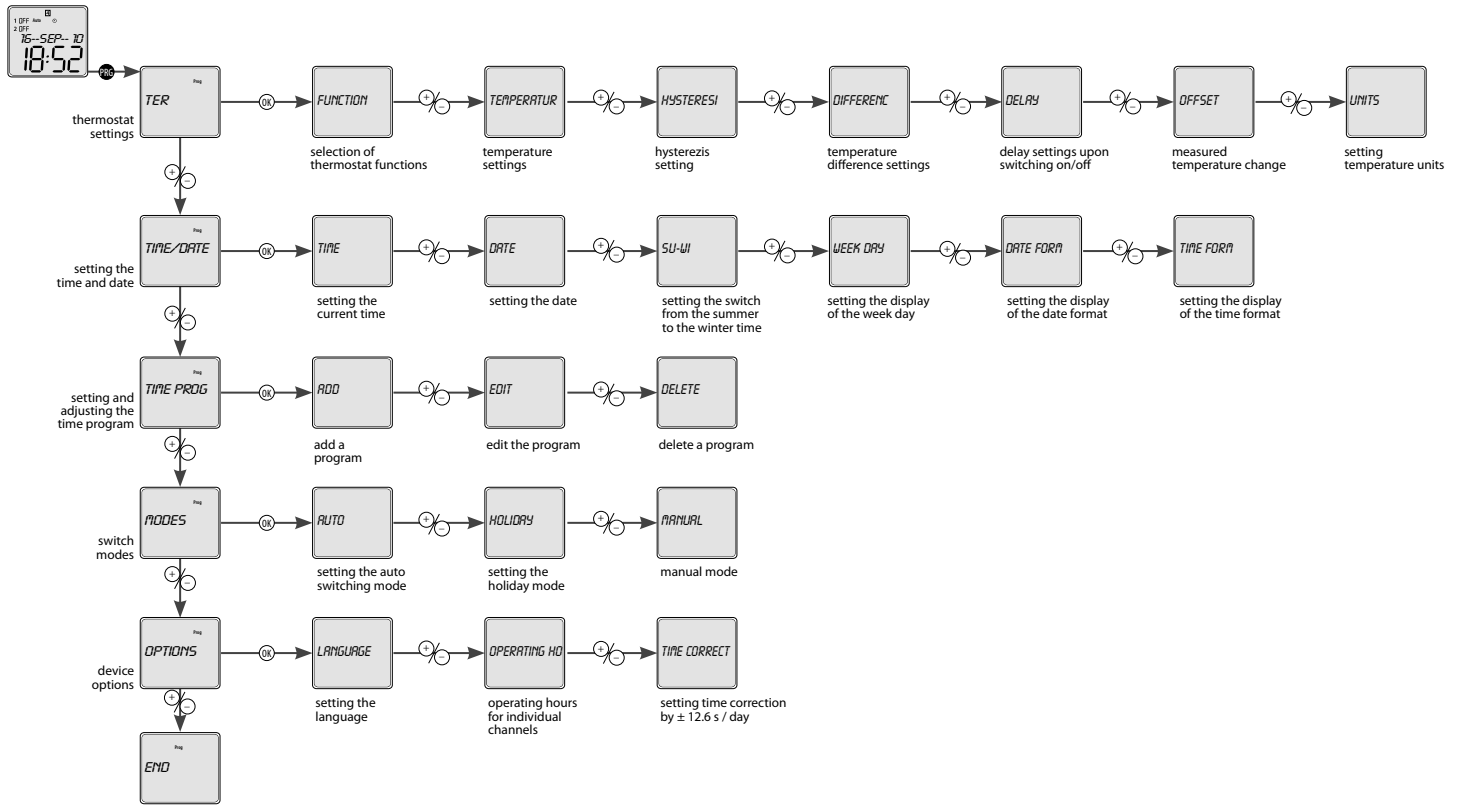

## TER display and settings

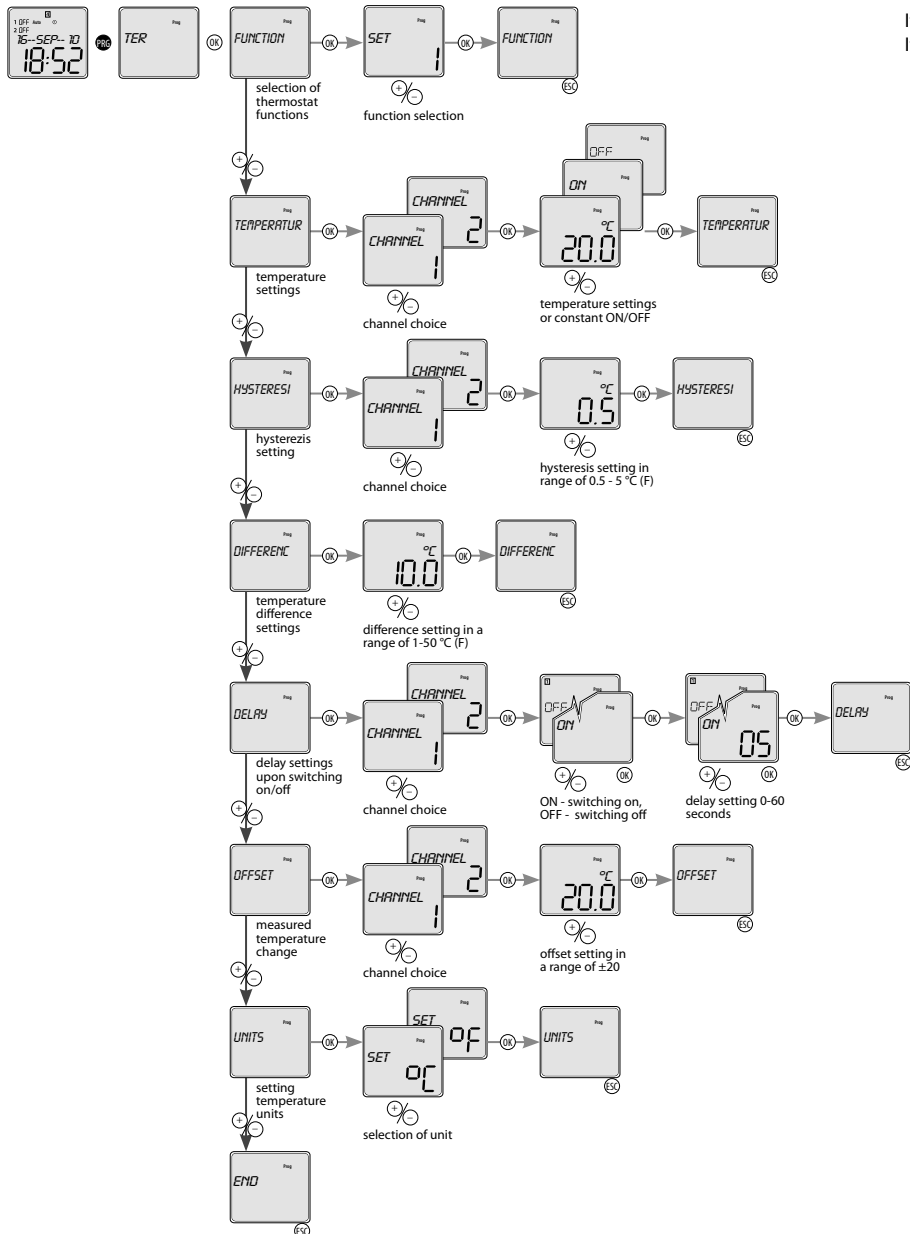

If the function *TER* is active, then symbol „Auto“ is displayed on the screen.  
If the entered switching delay is shown on the display „Auto + t“.

# Thermostat functions

## 1. 2 independent single-stage thermostat

Heater function

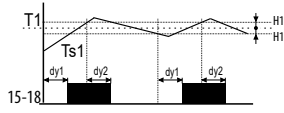

Heater function

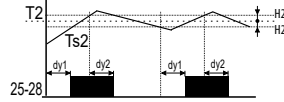

Legend:

- Ts1 - real (measured) temperature 1
- Ts2 - real (measured) temperature 2
- T1 - adjusted temperature T1
- T2 - adjusted temperature T2
- H1 - adjusted hysteresis for T1
- H2 - adjusted hysteresis for T2
- dy1 - set switching delay of the output
- dy2 - set delay on output breaking
- 15-18 output contact (for T1)
- 25-28 output contact (for T2)

Output contact switched until adjusted temperature is reached. Hysteresis eliminates frequent switching.

## 2. Dependent functions of 2 thermostats

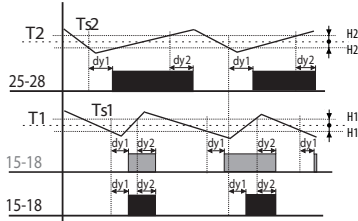

Legend:

- Ts1 - real (measured) temperature 1
- Ts2 - real (measured) temperature 2
- T1 - adjusted temperature T1
- T2 - adjusted temperature T2
- H1 - adjusted hysteresis for T1
- H2 - adjusted hysteresis for T2
- dy1 - set switching delay of the output
- dy2 - set delay on output breaking
- 25-28 output contact (for T2)
- 15-18 output contact (intersection T1 and T2)

Output 15-18 is closed, if temperature of both thermostats is below an adjusted level. When any thermostat reaches adjusted level, the contact 15-18 open. Serial inner connection of thermostats (logic function AND).

## 3. Differential thermostat

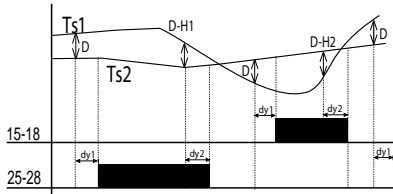

Legend:

- Ts1 - real (measured) temperature T1
- Ts2 - real (measured) temperature T2
- D - adjusted difference
- H1 - adjusted hysteresis for T1
- H2 - adjusted hysteresis for T2
- dy1 - set switching delay of the output
- dy2 - set delay on output breaking
- 15-18 output contact (for T1)
- 25-28 output contact (for T2)

Switching of output corresponds with input, which has lower temperature when difference is exceeded differential thermostat is used for keeping two identical temperature e.g. in heating systems (boiler and reservoir), solar systems (collector, reservoir exchanger), water heating (water heater, water distribution)etc.

## 4. 2-stage thermostat

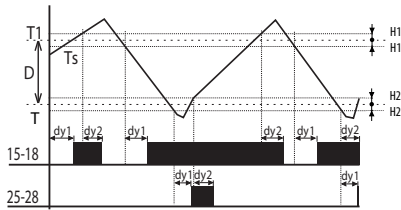

Legend:

- Ts - real (measured) temperature T1
- D - adjusted difference
- T1 - adjusted temperature T1
- T=T1-D
- H1 - adjusted hysteresis for T1
- H2 - adjusted hysteresis for T
- dy1 - set switching delay of the output
- dy2 - set delay on output breaking
- 15-18 output contact
- 25-28 output contact

Typical example of use for two-stage thermostat is e.g. in boiler-room, where there are two boilers from which one is main and the other one is auxiliary. The main boiler is managed according to set temperature and auxiliary boiler is switched in case temperature falls under set difference. Thus it helps to the main boiler in case outside temperature dramatically falls. In the range of set difference (D) output 15-18 functions as normal thermostat to input 1 (type 1). In case temperature falls under set difference, output 2 switches.

## 5. Thermostat with "WINDOW"

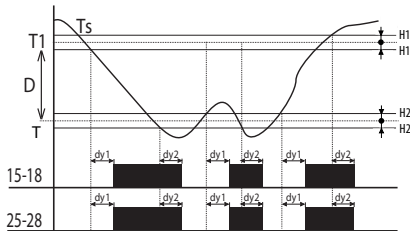

Legend:

- Ts - real (measured) temperature
- T1 - adjusted temperature
- T=T1-D
- H1 - adjusted hysteresis for T1
- H2 - adjusted hysteresis for T
- dy1 - set switching delay of the output
- dy2 - set delay on output breaking
- 15-18 output contact
- 25-28 output contact

Output is closed (heating) only if temperature is within adjusted range. If temperature is out of range, the contact opens. T is set as T1-D. The function is used for protection of gutters against freezing.

## 6. Thermostat with dead zone

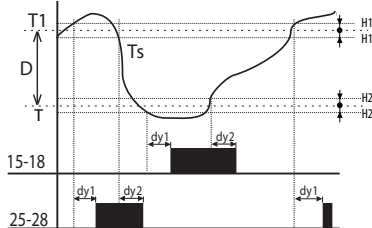

Legend:

- Ts - real (measured) temperature
- T1 - adjusted temperature
- T=T1-D
- H1 - adjusted hysteresis for T1
- H2 - adjusted hysteresis for T
- dy1 - set switching delay of the output
- dy2 - set delay on output breaking
- 15-18 output contact (heating)
- 25-28 output contact (cooling)

In case of thermostat with a „dead zone“, it is possible to set temperature T1 and a difference (respectively a width of dead zone D). If temperature is higher than T1, output contact of cooling switches ON; if the temperature gets below T1, the contact switches OFF. If the temperature gets below temperature T, the contact of heating switches ON and it switches OFF when temperature T is exceeded. This function can be used for example for automatic air warming and cooling in ventilation so the sit is always within the range T1 and T.

## Time and date setting

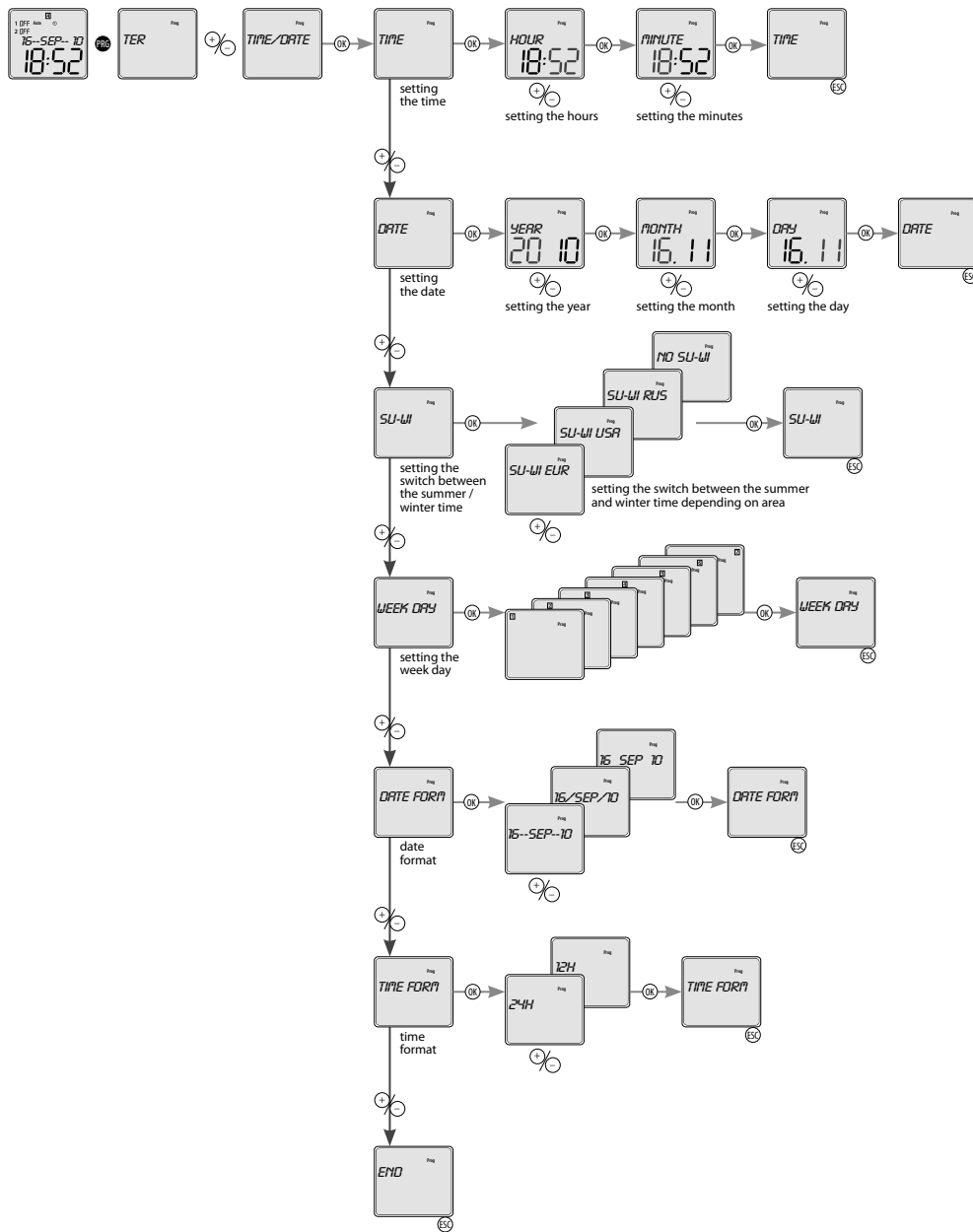

After entering the date is normally calculated and numbered by day of the week: Monday = first day of the week.

Numerical showing the day of the week, may not correspond to the calendar day of the week. It can be set in the menu „Display settings of the week“. Set the number from the set to the current date.

Note: After the date is changed, the numbering of days back to the standard numbering ie Monday = first day of the week.

# Time program

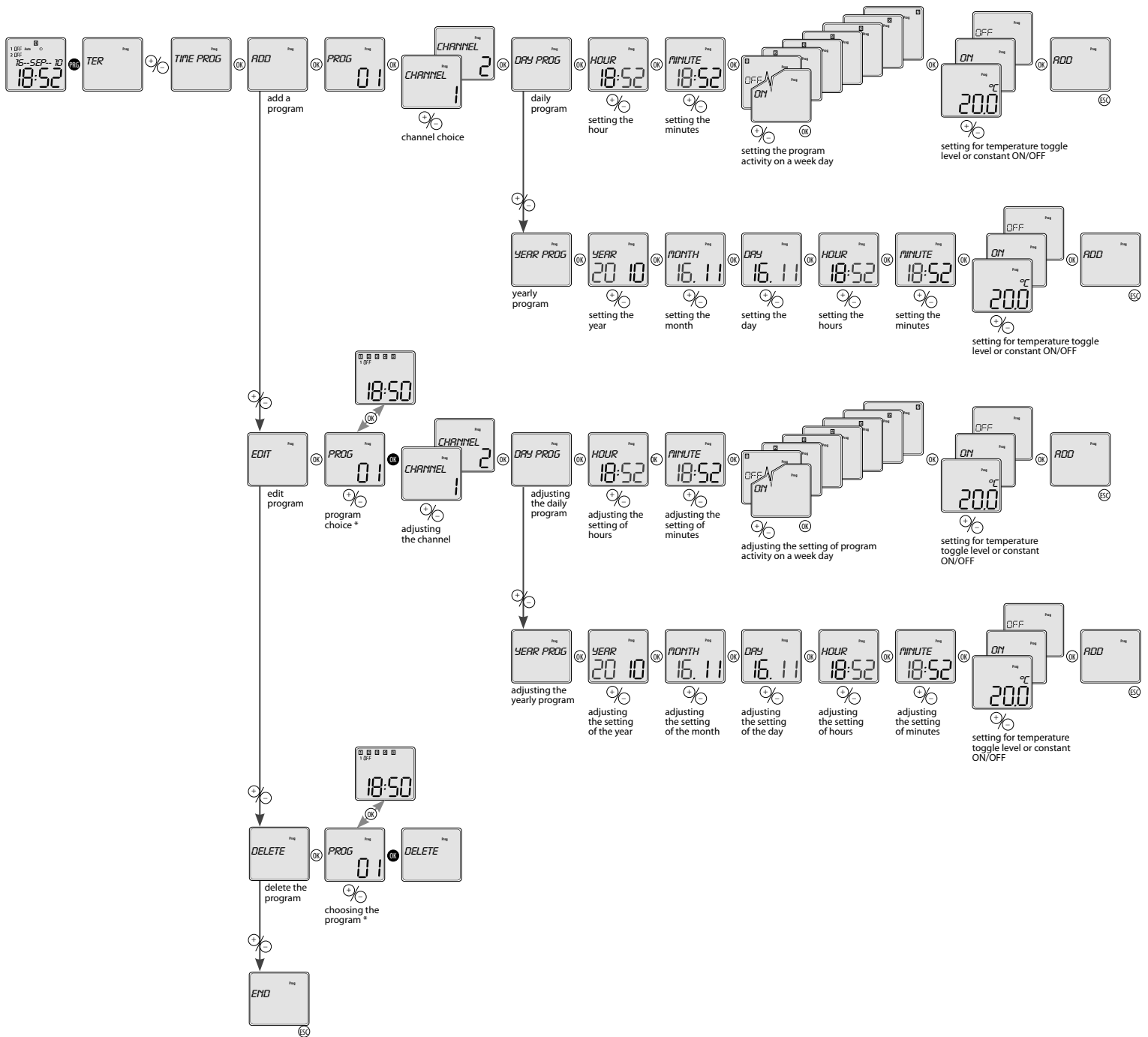

\* OFF

- 1. ON - permanently ON
- 1. OFF - always off
- 1. OR - controlled by temperature function

By shortly pressing **OK**, you can toggle between the program number and the display of its settings. Use **↻** to toggle preset programs. By holding **OK** you can proceed with the required step - CHANGE / DELETE. If you do not want to proceed, press **ESC** to go to the main settings without any change.

If the program memory is full, you will see *FULL* on the display.

If the programs memory is empty and you want to change or erase a program, the display will read *EMPTY*.

## Setting the switching modes

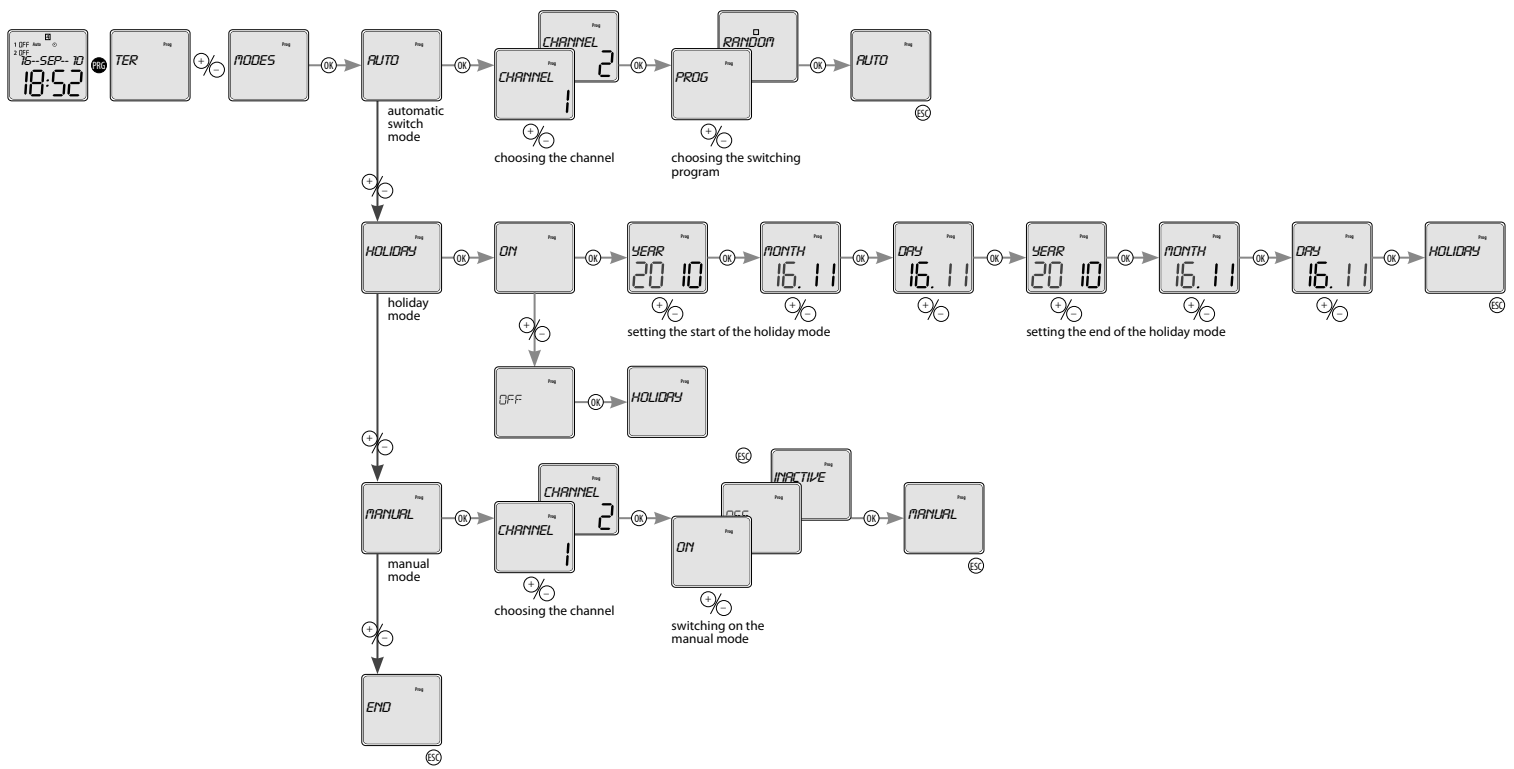

What you see on the display:

- when a random mode is activated - *RANDOM* - the symbol is lit
- vacation mode *HOLIDAY*:
  - the illuminated symbol  indicates the vacation mode.
  - the flashing symbol  indicates the vacation mode.
  - the symbol  is not illuminated if the vacation mode is not set or has.
- when the manual mode is activated, the symbol is lit  and the manually controlled channel is flashing.

## Settings options

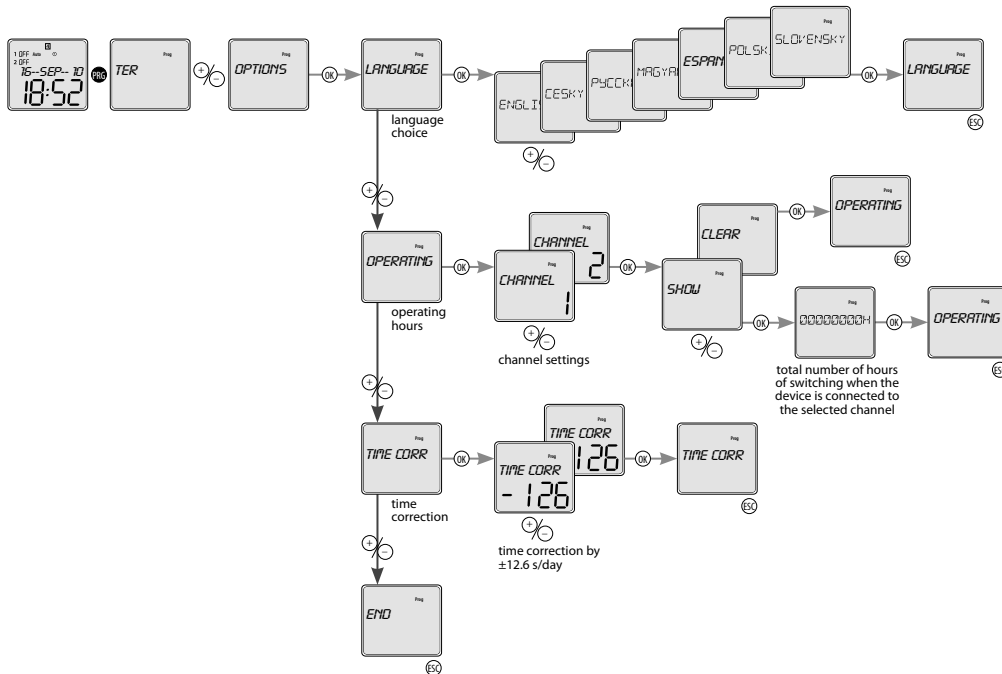

Time correction:

The shift unit is 0.1s per day.

The numeric value refers to seconds per 10 days.

Time correction is factory-set and individual for each product so that the real-time clock would run with minimum deviation. The time correction value can be arbitrarily adjusted, but after product RESET, the value returns to factory settings.

## Deleting of all programs



in starting menu (time is shown on display) - press simultaneously button **PROG** and **OK** and display announces a notice ALL

press button **OK** to complete the deleting of all set programs

## Reset

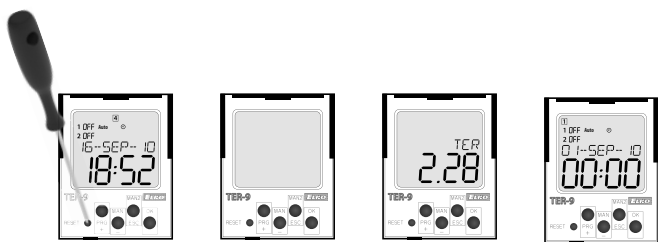

Performed by shortly pressing the hidden RESET button with a blunt-pointed object (e.g. a pencil or screw-driver with a diameter of at most 2 mm).

The type of device and software version will be displayed for 1 second, then the device will enter default mode. This means that the language is set to EN, all data is zeroed (thermostat function, time/date, user programs, device options function).

## Battery replacement



You can change the battery without disassembling the device.

### CAUTION

- only change the battery when the device is disconnected from power supply !!!  
- the date and time must be reset after changing the battery !!!

- remove the plug-in module with the battery
- replace the original battery
- enter a new battery so that its upper edge (+) lines up with the plug-in module
- slide the plug-in module in the device and pay attention to polarity (+ up) - for roughly 1 s, the display will show the name and the software version
- you can connect the device to power supply

## An example of TER-9 programming

Setting the TER-9 in the function: two dependent thermostats with temperature setting T1 = 10°C a T2 20 °C with hysteresis setting T1 = 2 °C a T2 = 1°C. With automatic controlled temperature change on 18.11.2010 at 6:52 p.m. to the temperature T1= 15 °C.

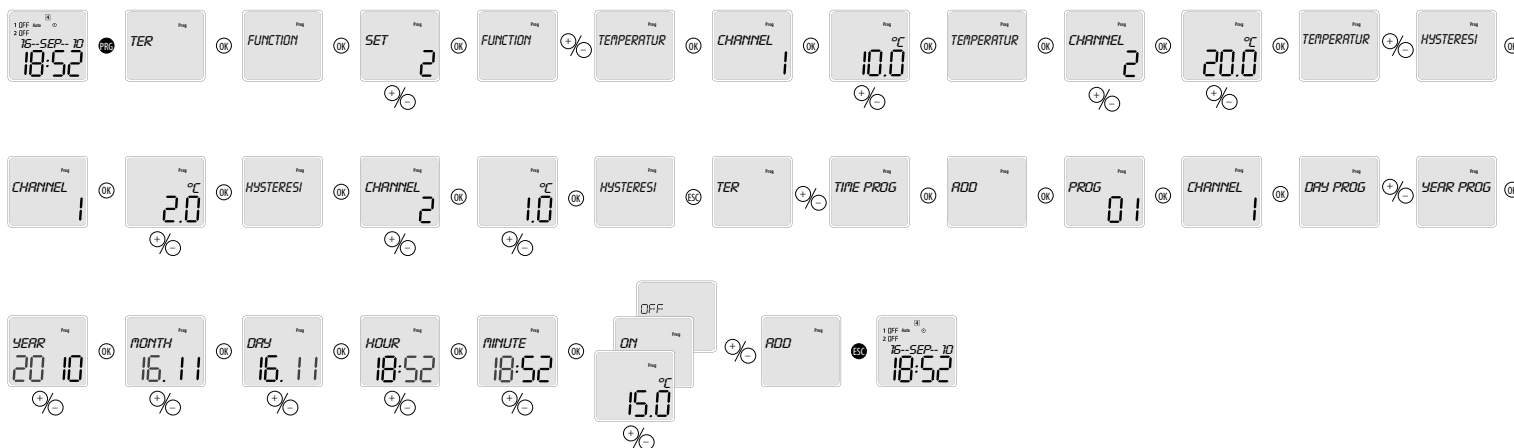

## Warning

Device is constructed for connection in 1-phase main alternating current voltage AC 230 V or 24 V AC/DC (based on type of device) and must be installed according to norms valid in the state of application. Connection according to the details in this direction. Installation, connection, setting and servicing should be installed by qualified electrician staff only, who has learnt these instruction and functions of the device. This device contains protection against overvoltage peaks and disturbances in supply. For correct function of the protection of this device there must be suitable protections of higher degree (A, B, C) installed in front of them. According to standards elimination of disturbances must be ensured. Before installation the main switch must be in position "OFF" and the device should be de-energized. Don't install

the device to sources of excessive electro-magnetic interference. By correct installation ensure ideal air circulation so in case of permanent operation and higher ambient temperature the maximal operating temperature of the device is not exceeded. For installation and setting use screw-driver cca 2 mm. The device is fully-electronic - installation should be carried out according to this fact. Non-problematic function depends also on the way of transportation, storing and handling. In case of any signs of destruction, deformation, non-function or missing part, don't install and claim at your seller it is possible to dismount the device after its lifetime, recycle, or store in protective dump.